

# TIE-Interceptor

本体パーツ

本の作り方はタイファイターを参考にしてください。

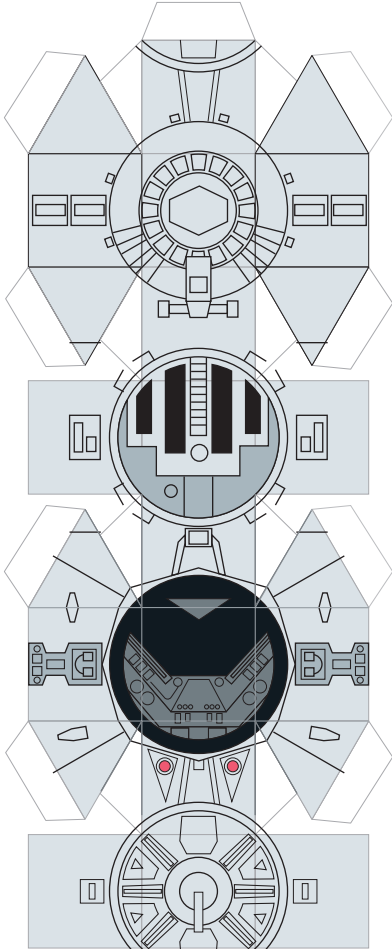

F

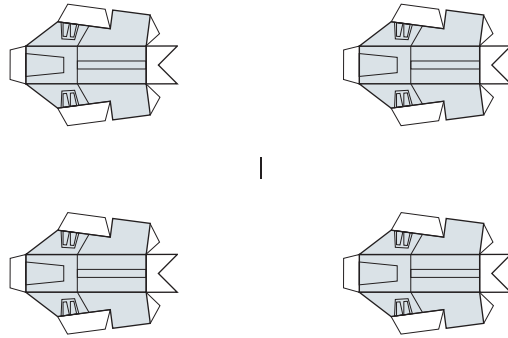

I



J

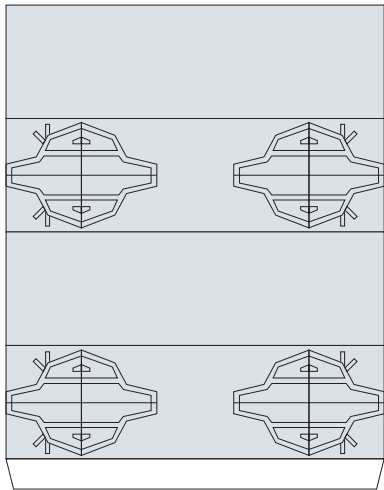

G



H

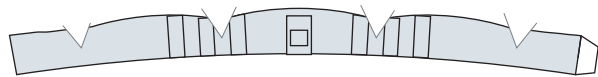

L

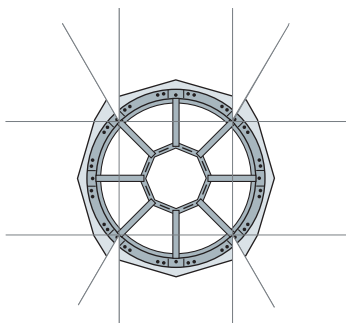

K

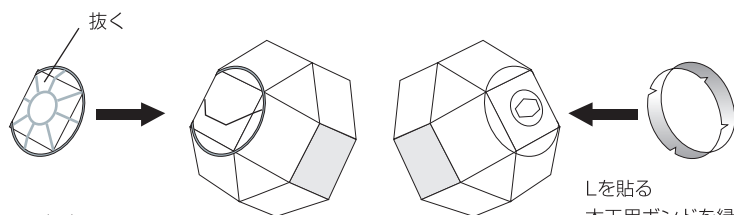

Kを貼る  
コクピットフレームの窓を抜く作業です。  
(※細かい作業なので上級者向きです。)

Lを貼る  
木工用ボンドを縁に多めに塗り  
切り込みを角に合わせ接着。  
(※塗り足しが無いので上級者  
向きです。)

# TIE-Interceptor

## ソーラーパネルパーツ

2枚プリントしてください。

タイファイターと違い抜きではなくPのパーツにSを貼り付けてください。

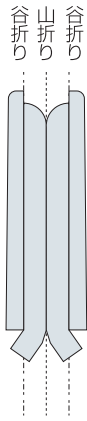
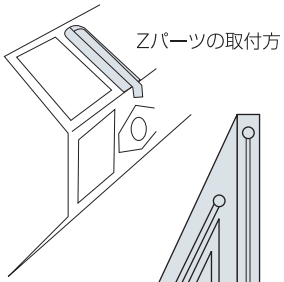

Z

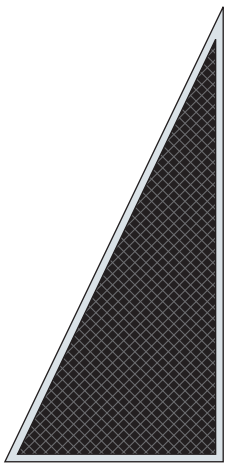
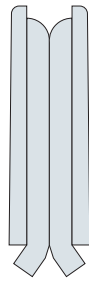
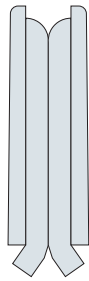
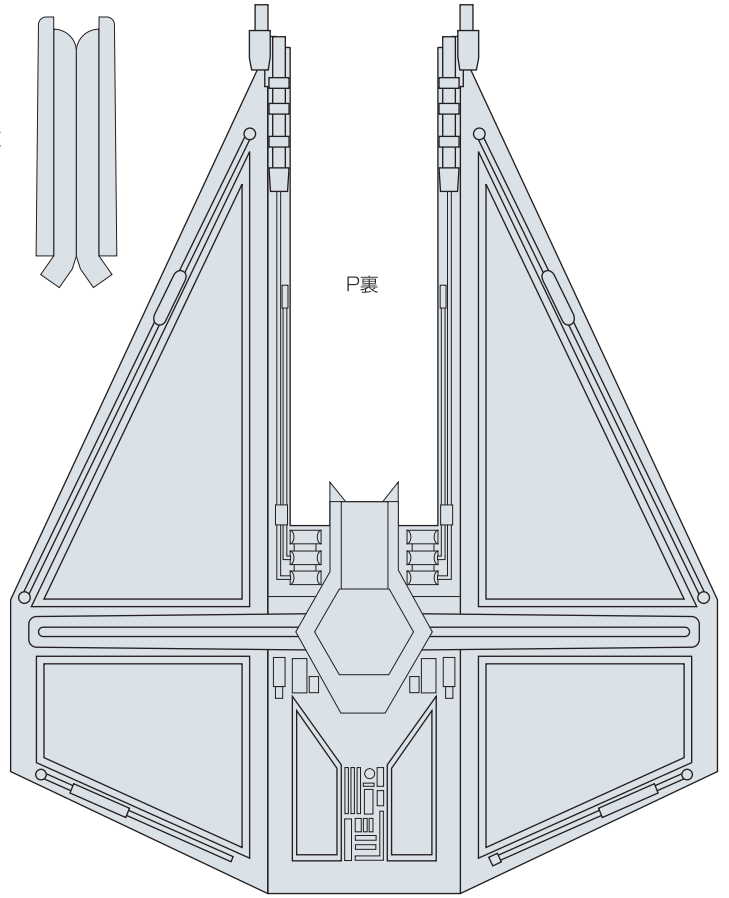
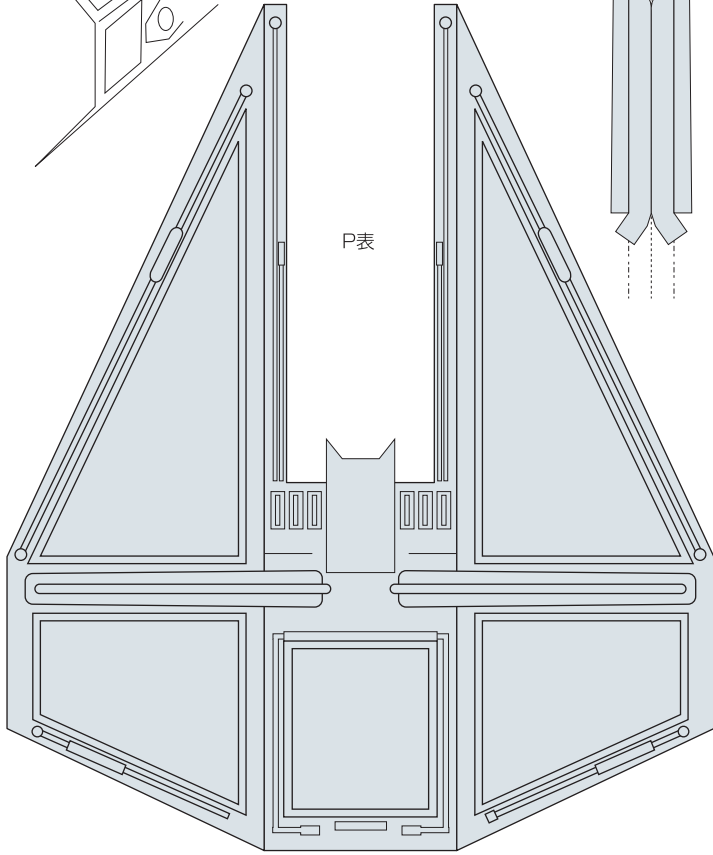

S表

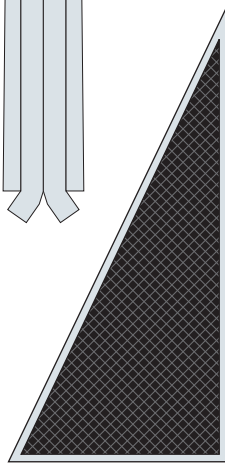
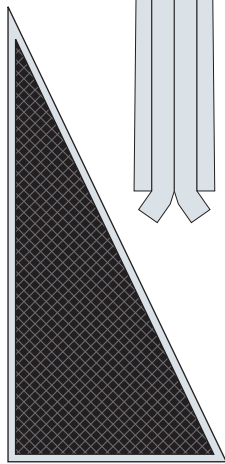

S裏

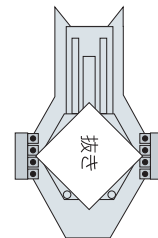
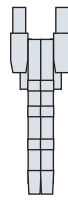
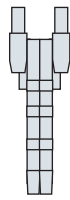
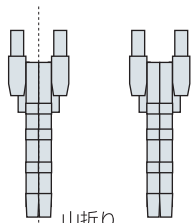
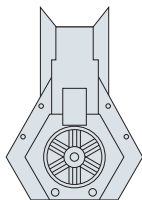
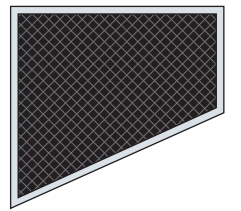
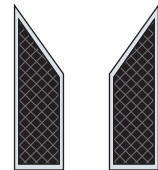
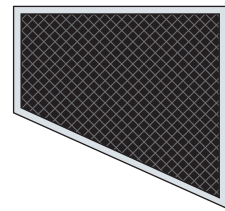
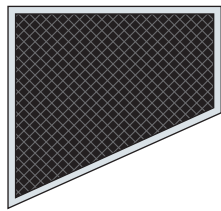
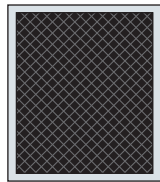
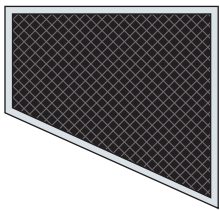
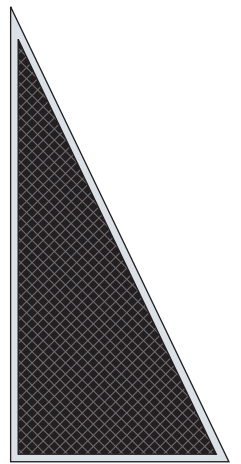

山折り

# Display Stand

タイファイター・インターセプター用スタンド

