

4枚プリントしてください。

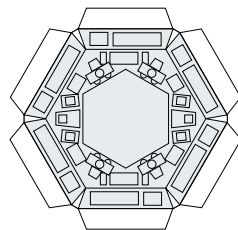

A

B

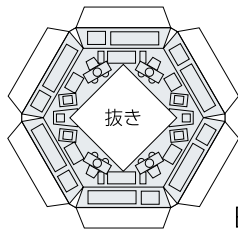

E

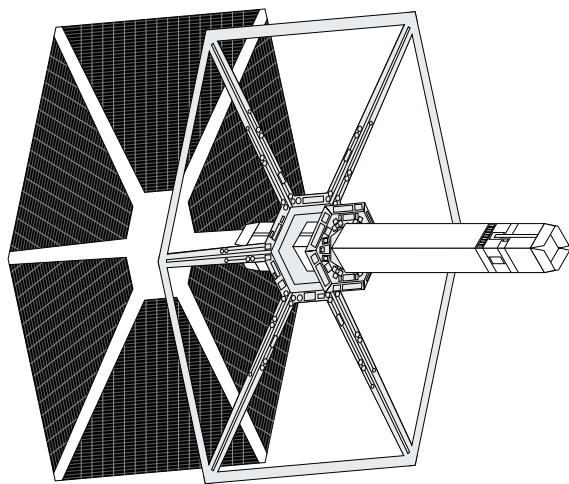

内側用
支柱をE、Cに通しDにのり付け固定します。

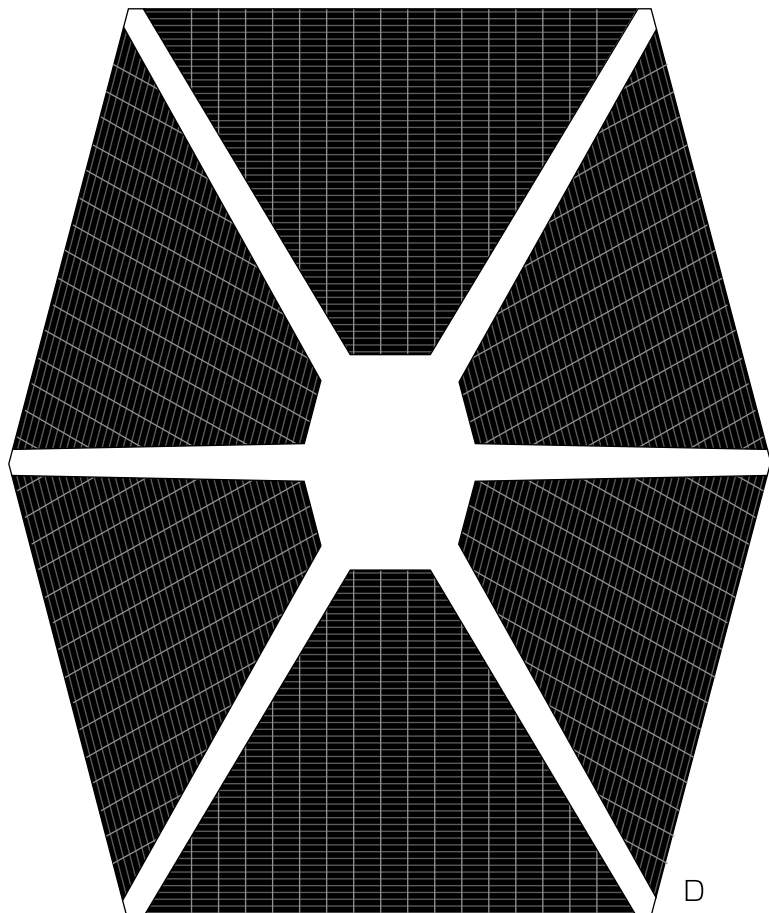

D

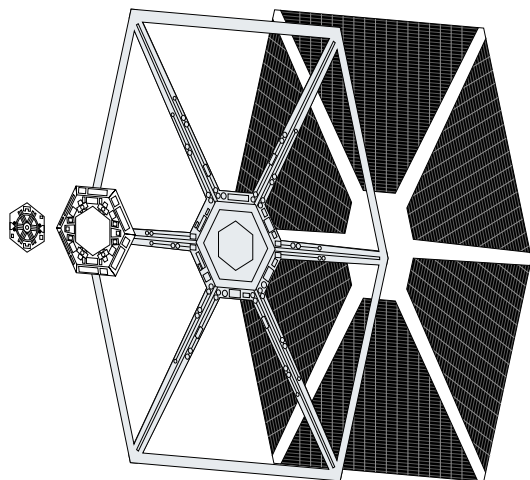

外側用
ABCDを順に張り合わせていく

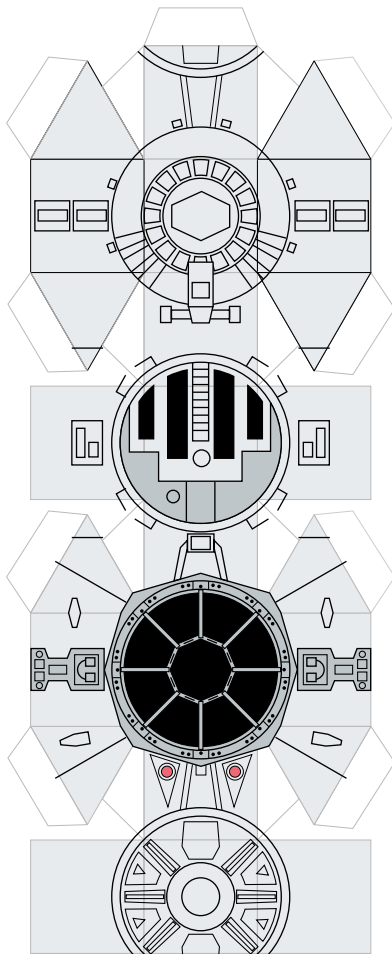

F

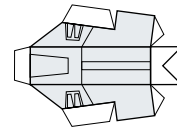
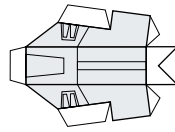

I

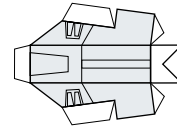
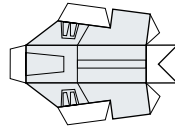

J

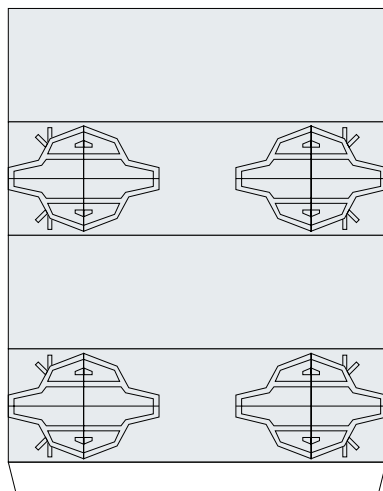
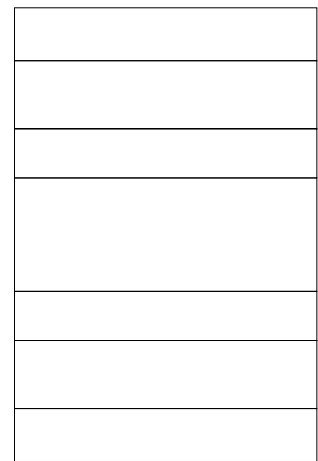

G



H

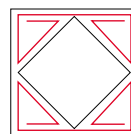

G、H断面図

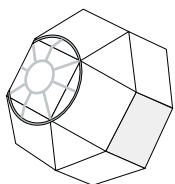

Fを組む

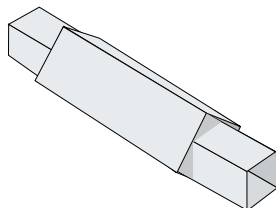

GにHを通す。

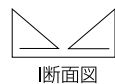

I断面図

Iを上図の用に組みGの固定用にする。

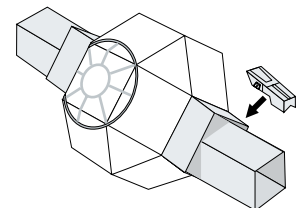

Display Stand

タイファイター・インターセプター用スタンド

