

基礎パーツ：2枚プリントしてください。  
foundation parts:Two sheets are need.

F-1

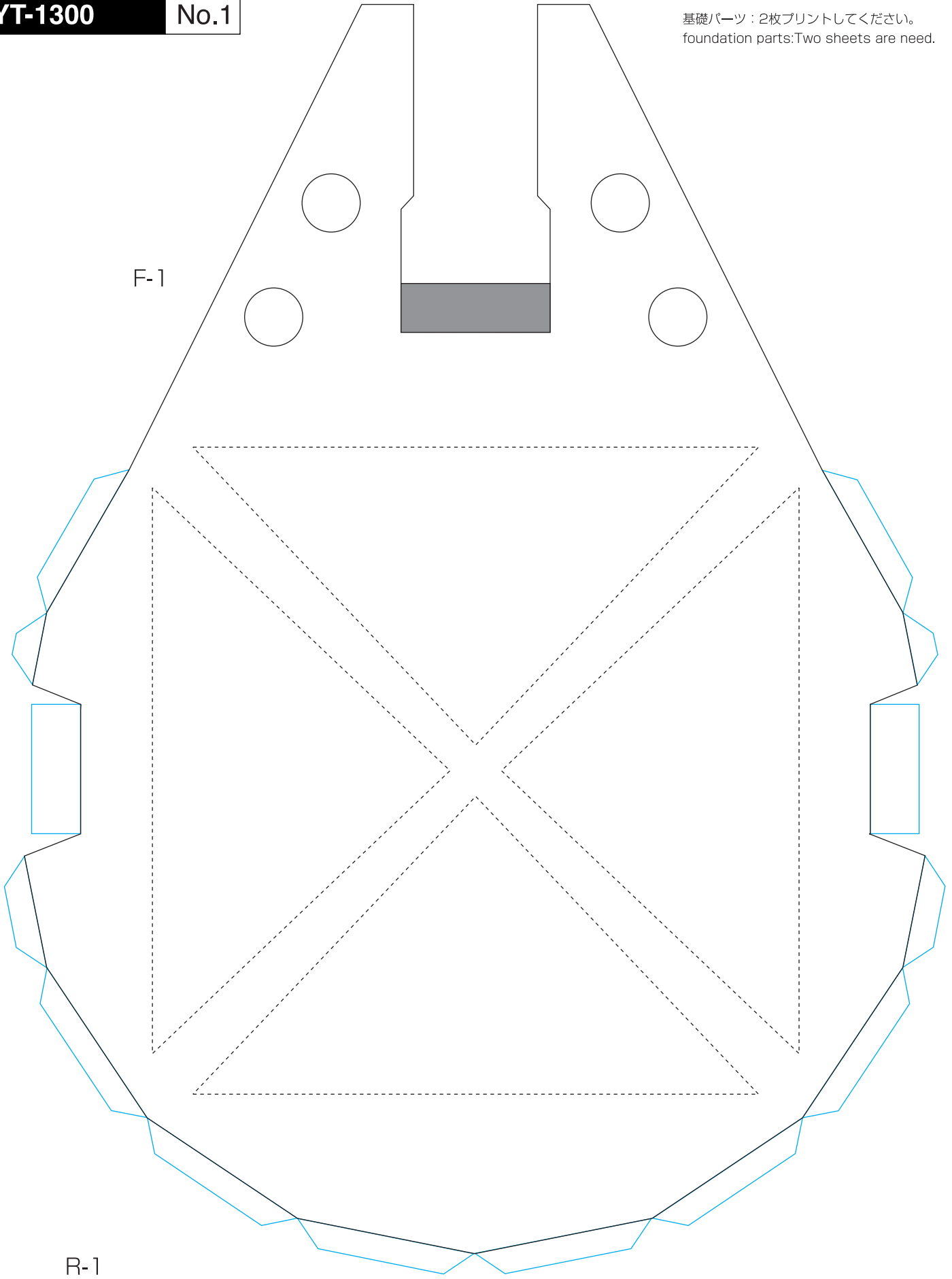

R-1

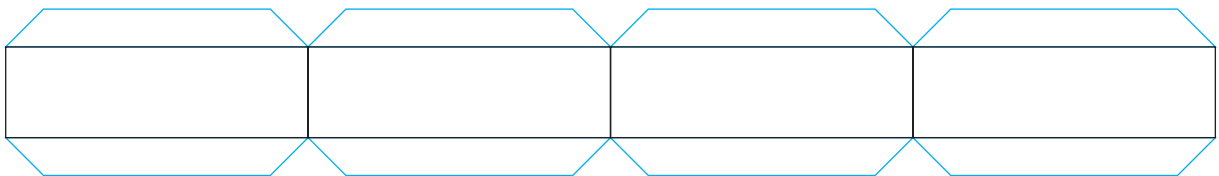

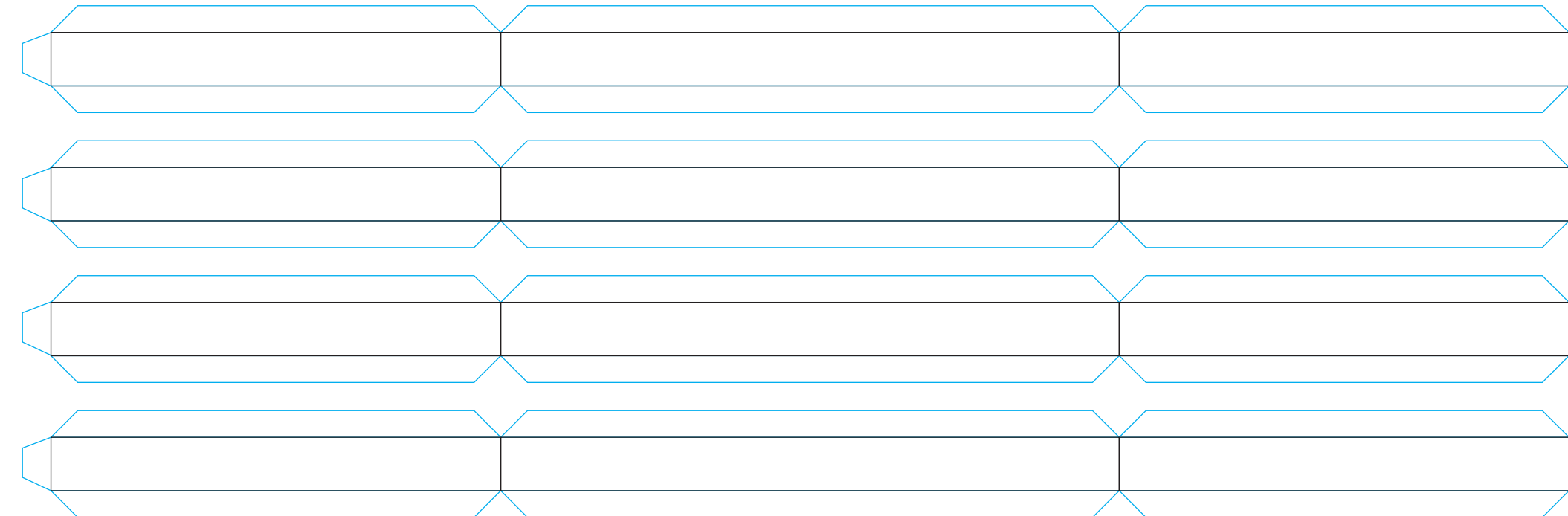

R-2

内部補強パーツ reinforcement parts

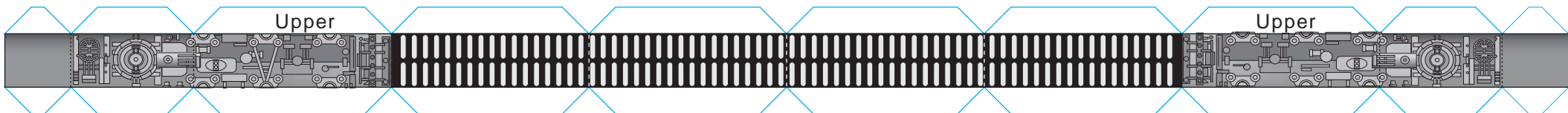

F-4

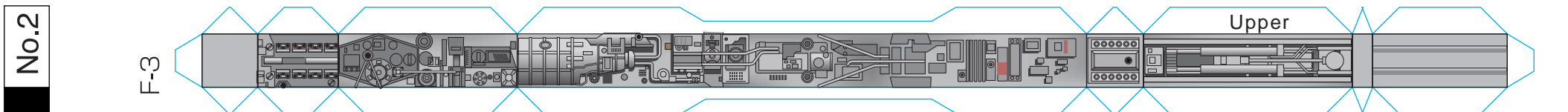

F-3

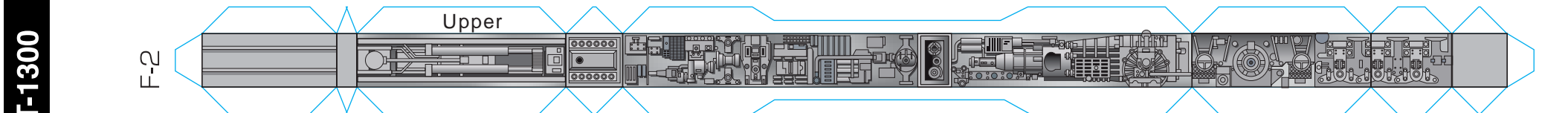

F-2

YT-1300 No.2

表面用  
apper

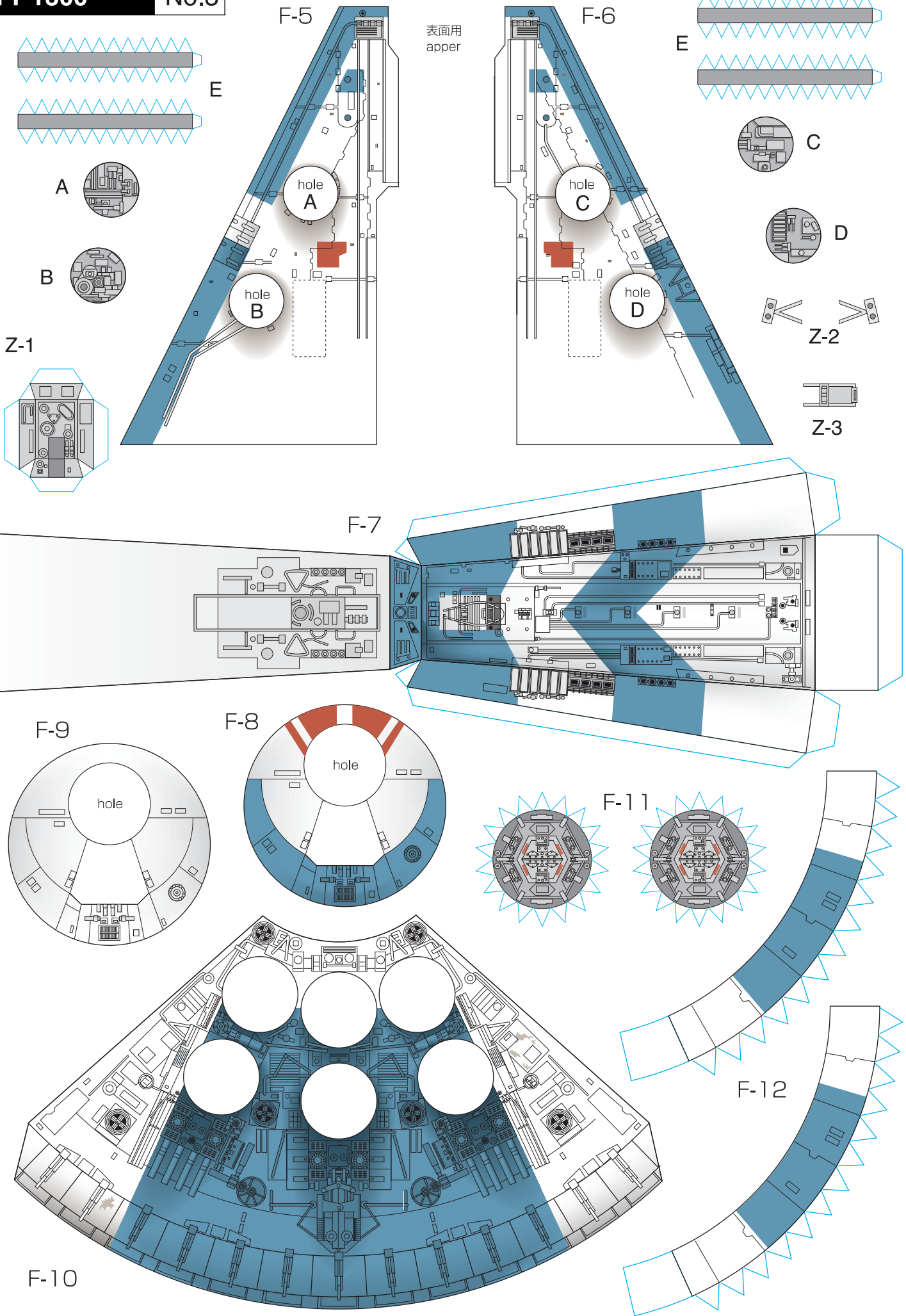

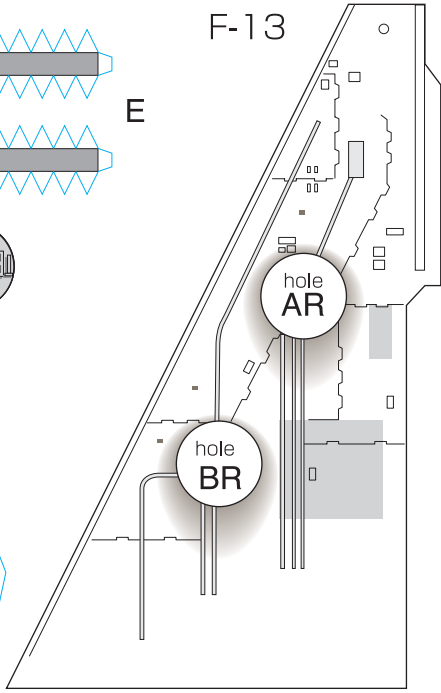
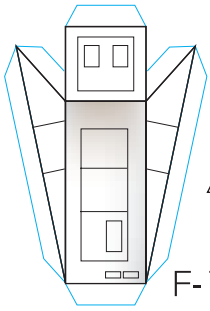
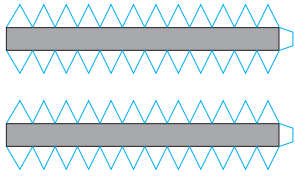

下面用  
under

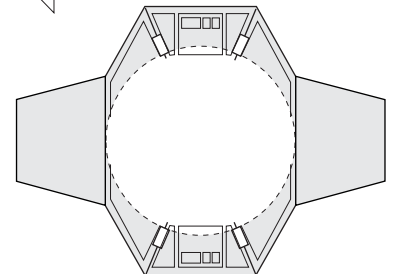
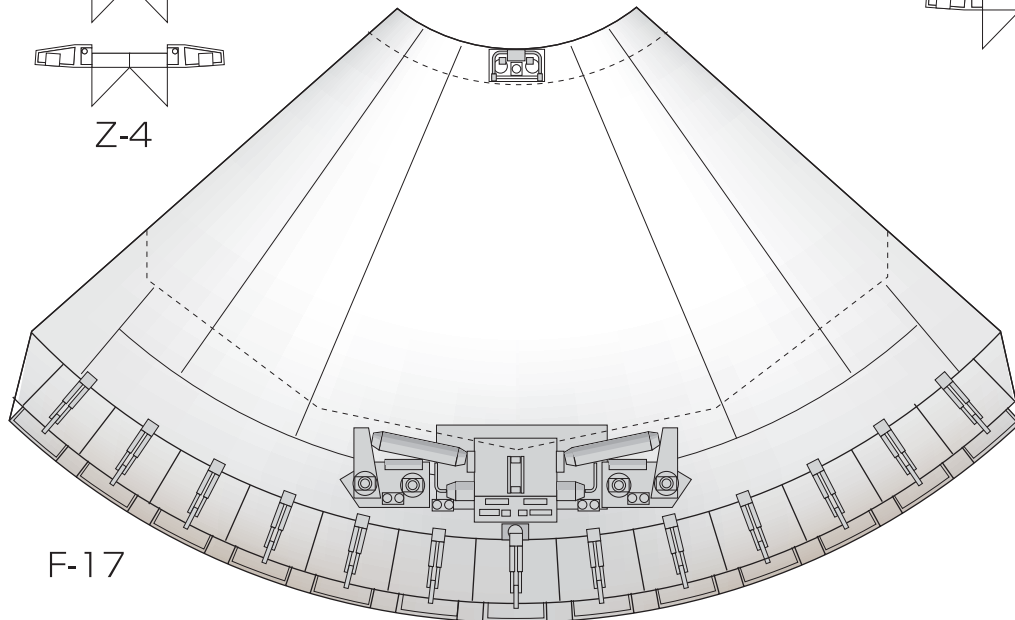
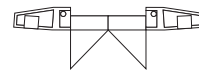
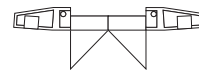
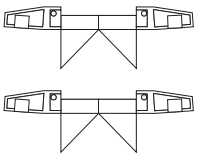
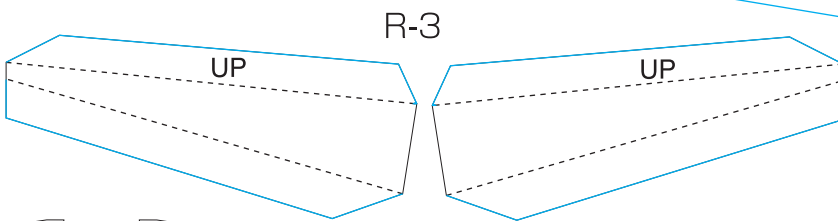
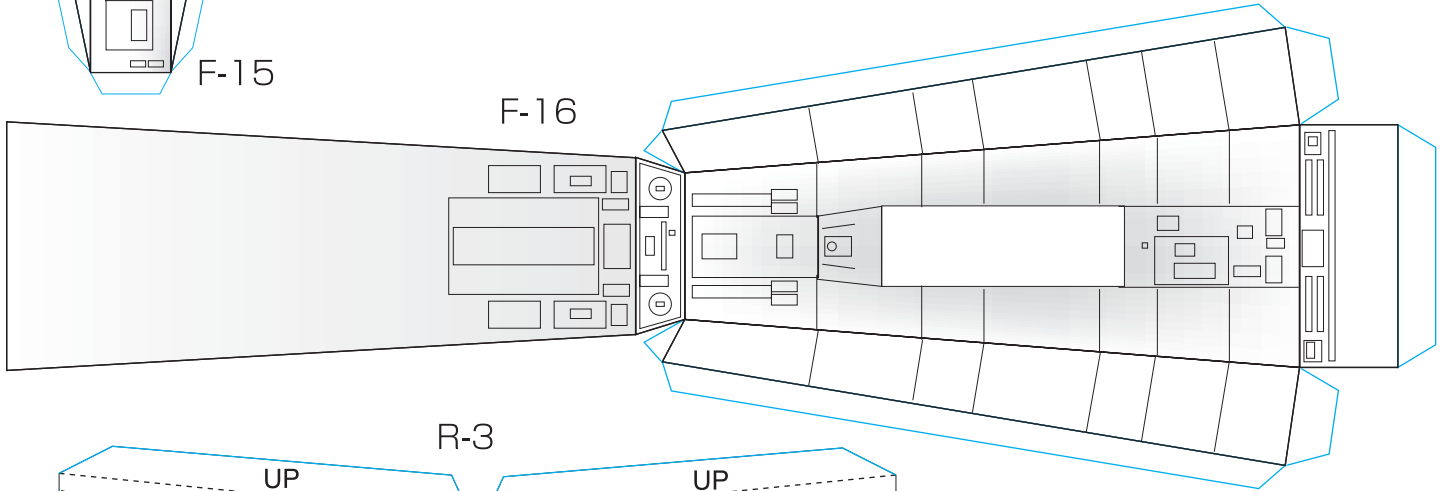
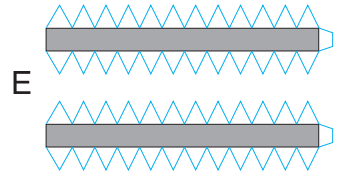
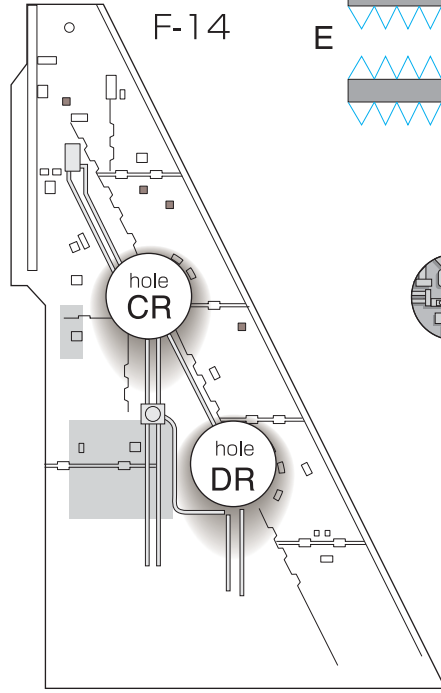

F-18

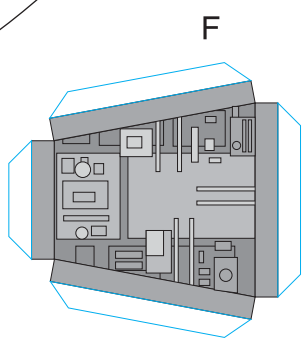
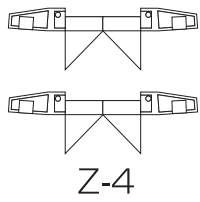
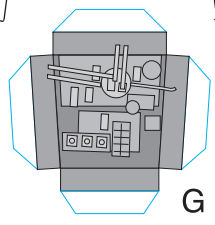
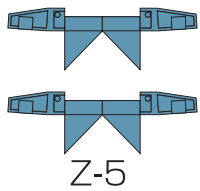
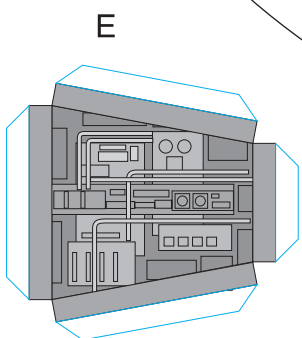
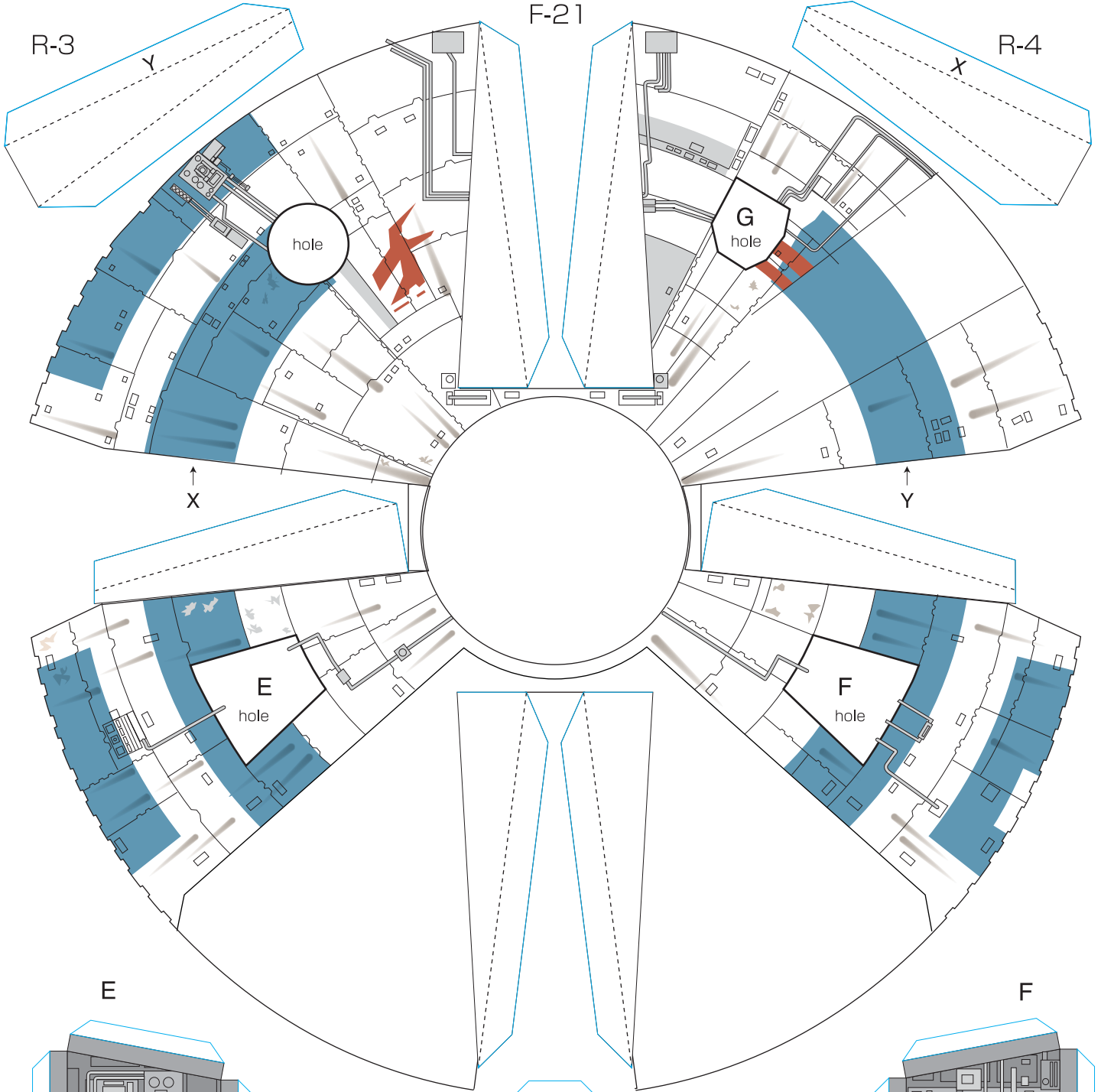
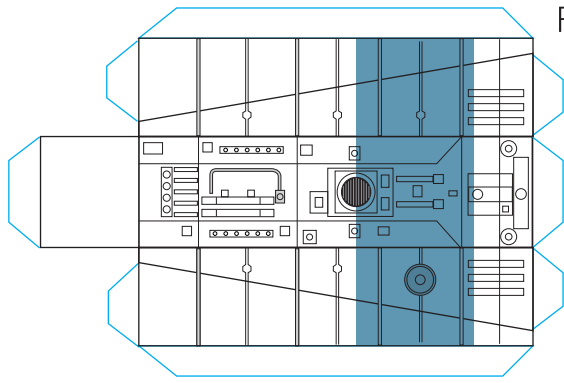
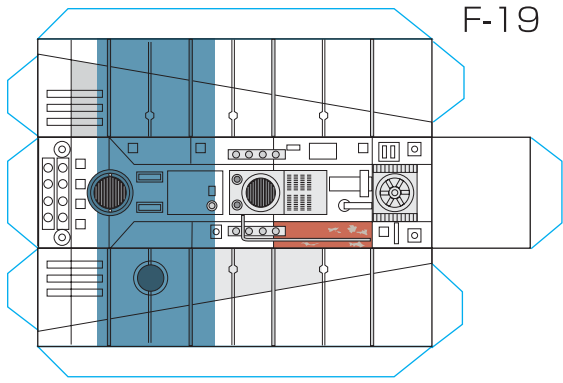

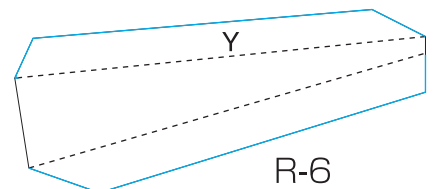
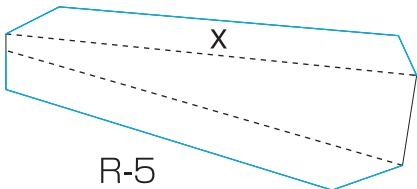
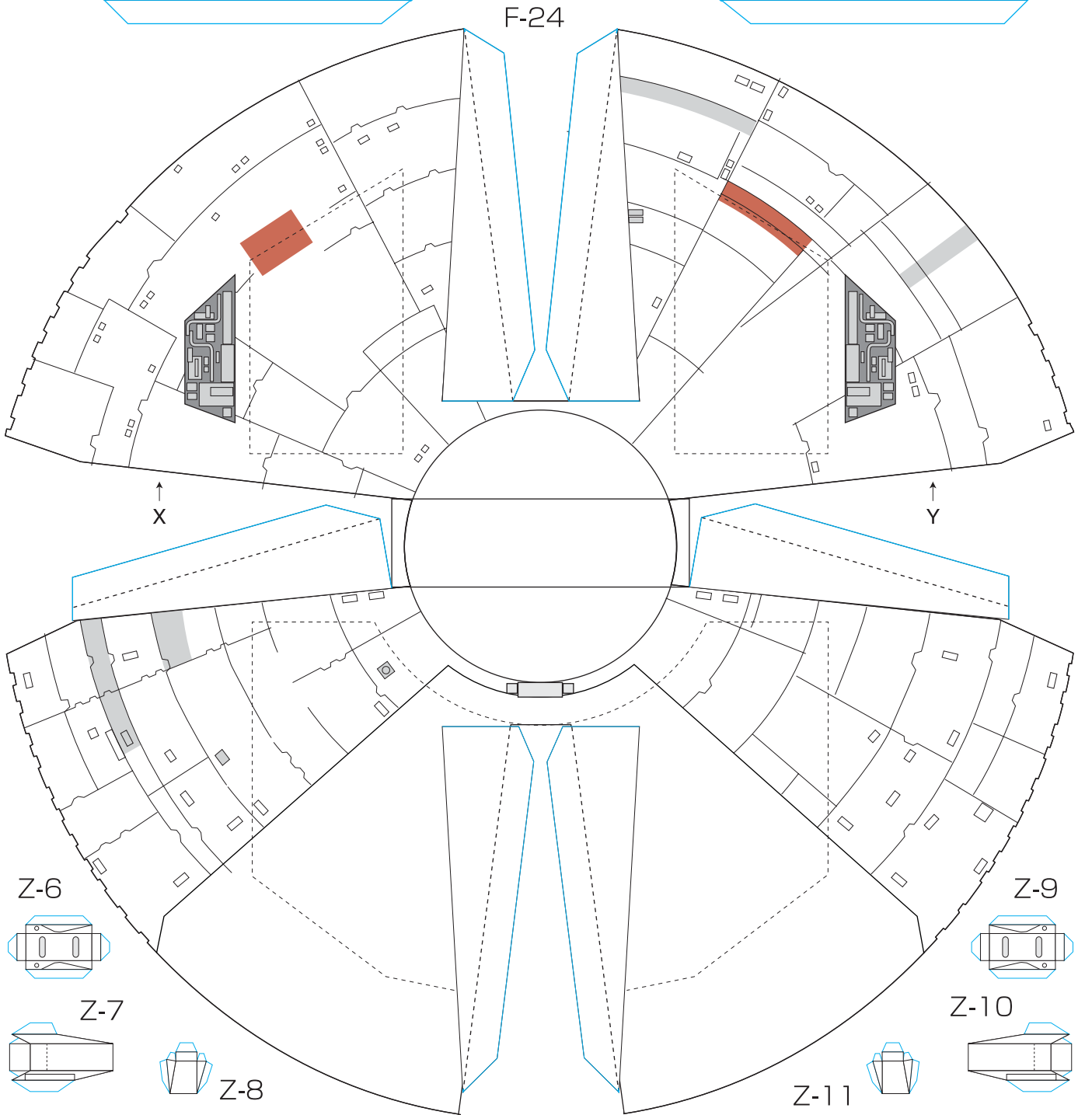
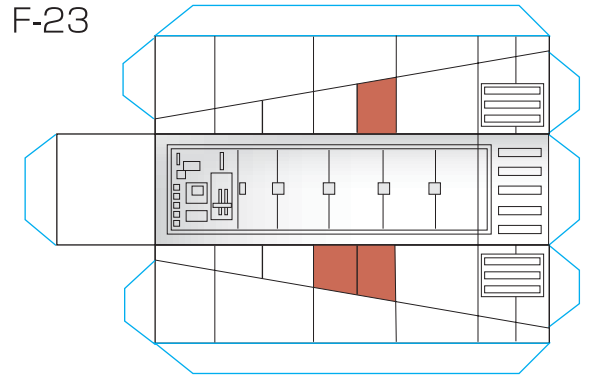
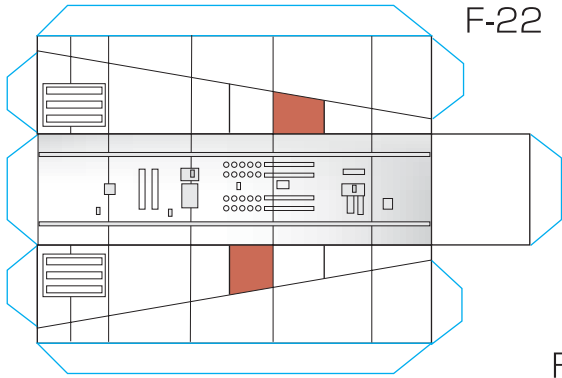

F-25

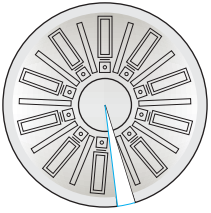

F-27



F-26

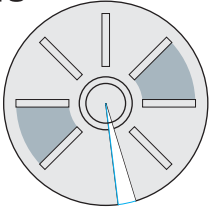

F-28

F-29

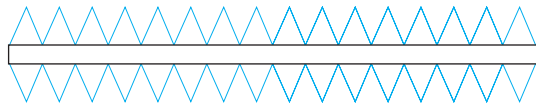
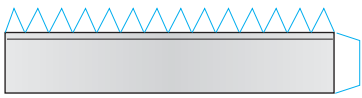

F-31

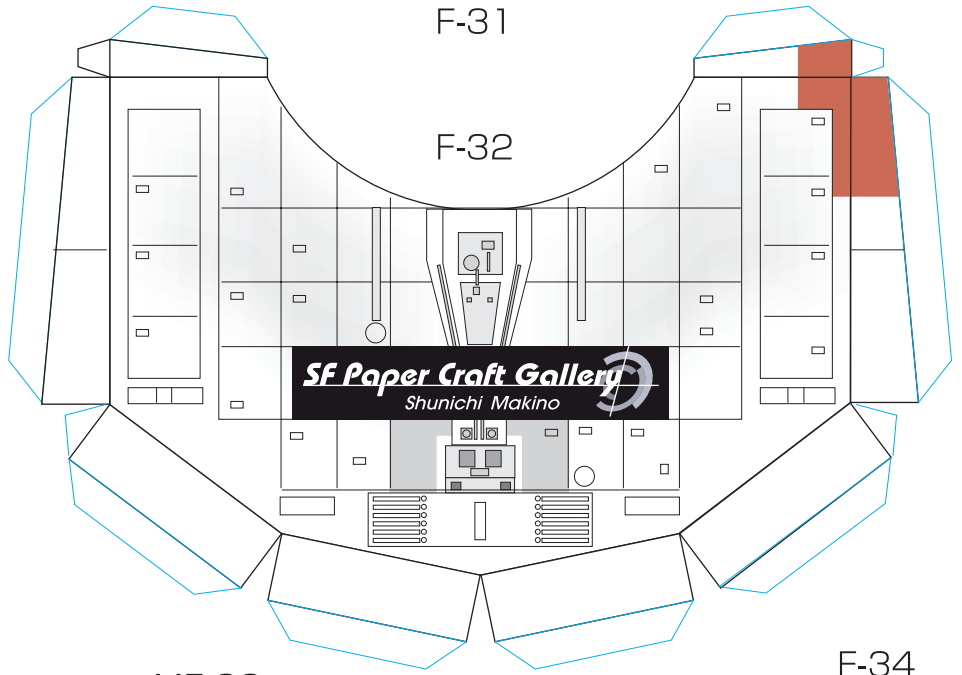

F-32

SF Paper Craft Gallery  
Shunichi Makino

F-30

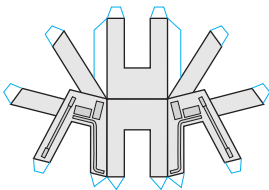

MF-33

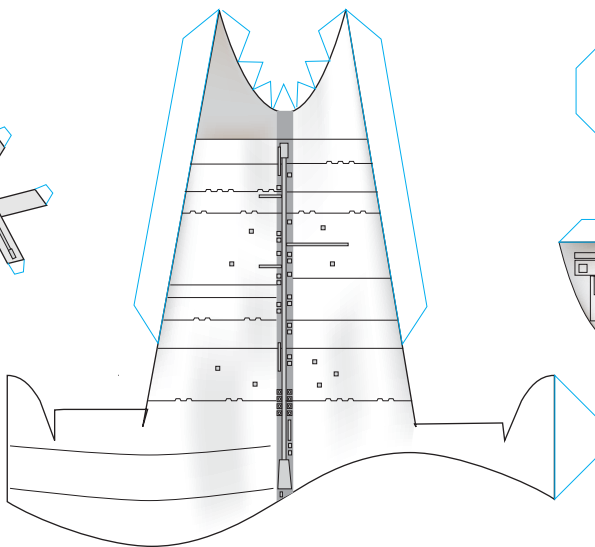

F-34

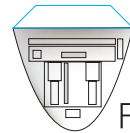
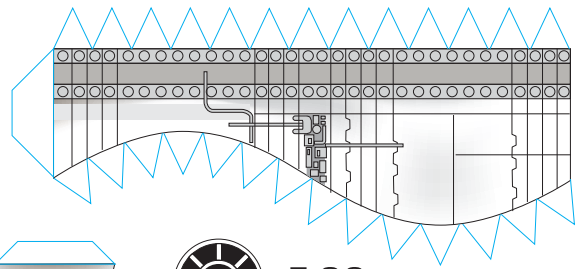

F-35



F-36

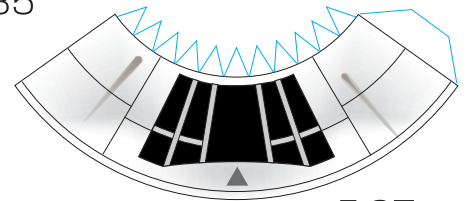

F-37

F-38

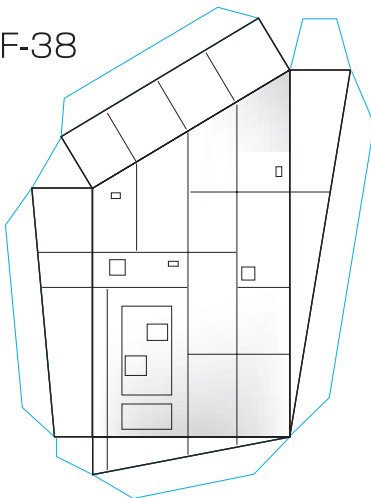

F-39

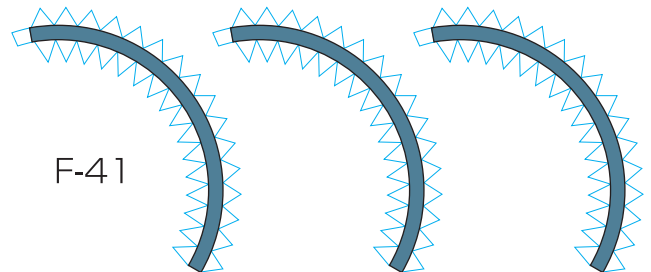
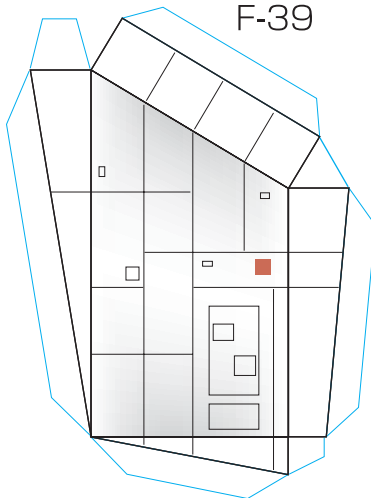

F-41

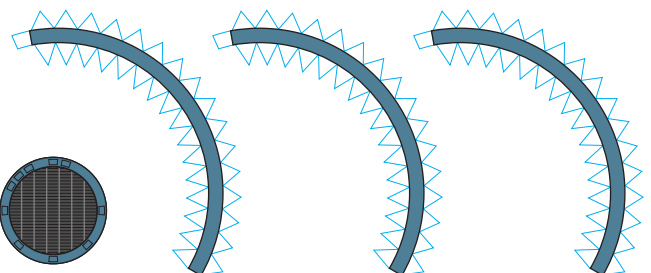

F-40

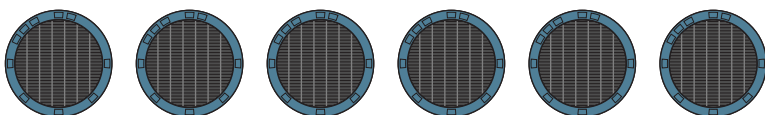

R-7

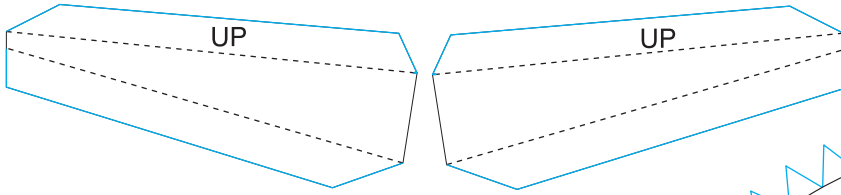
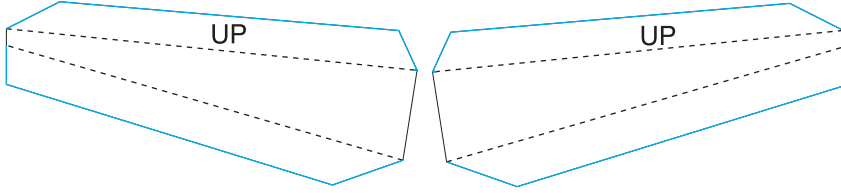
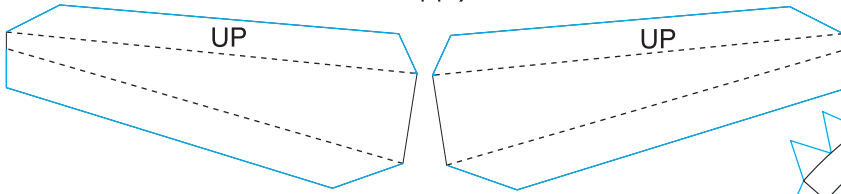

F-42

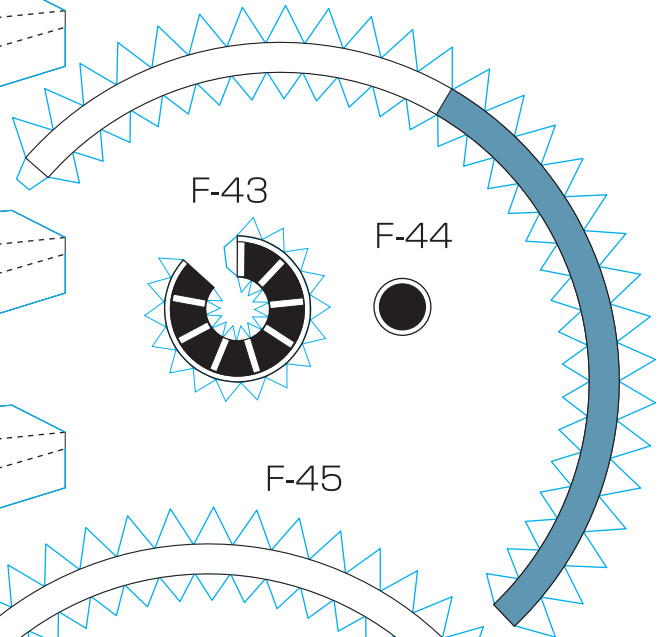

F-43

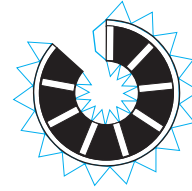

F-44



F-45

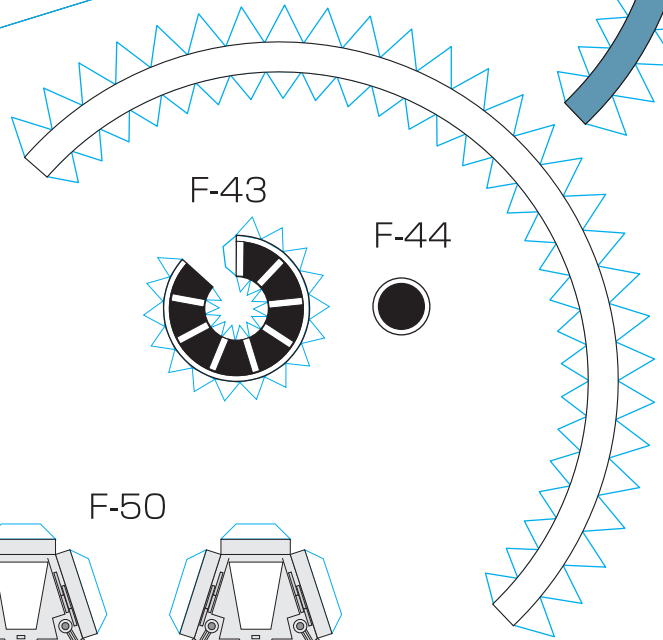

F-43

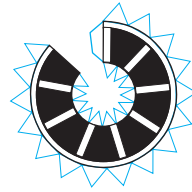

F-44



F-46

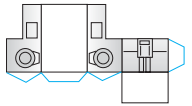

F-47

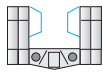
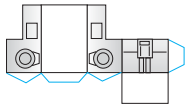
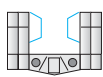

F-48

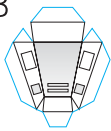
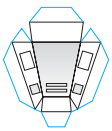

F-49



F-50

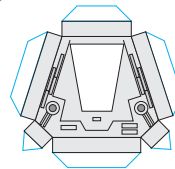
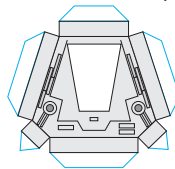

F-51

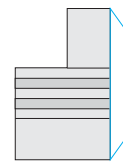
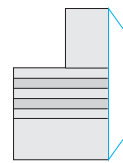
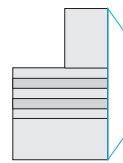
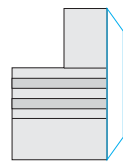
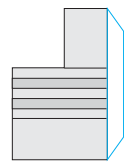
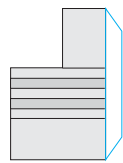
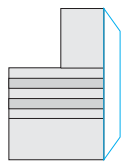
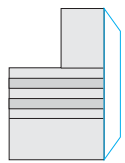



X-1

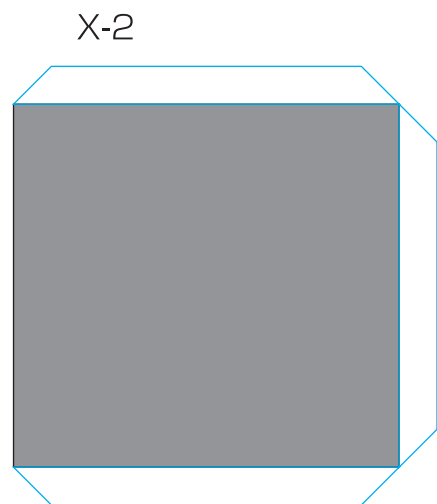
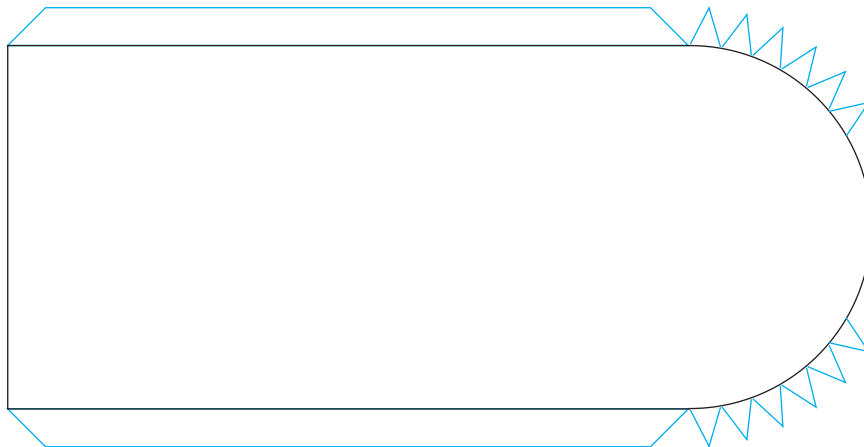

X-3

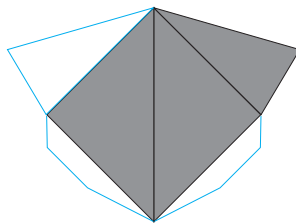

X-4

